

KOHLER®

Kelston®
ContinuousClean tall two-piece elongated toilet, 1.28
gpf
K-30688

Features

- Two-piece design
- Elongated bowl offers added room and comfort
- Tall height offers seating 2-1/2" (63.5 mm) higher than Comfort Height® for enhanced comfort, ease of sitting and standing, and gracious accessibility
- 1.28 gpf (4.8 lpf)
- Left-hand Polished Chrome trip lever
- 2-1/8" (54 mm) fully glazed trapway
- Revolution 360® flushing technology generates a forceful swirling motion to keep the bowl clean longer
- Sanitary guard where bowl and tank meet for ease of cleaning
- CleanCoat™ surface treatment inhibits the growth of water scale and mineral stains for improved ease of cleaning
- ContinuousClean system automatically dispenses cleaning solution with every flush
- Works with any white toilet bowl cleaner tablet. Tablets last up to six months in ContinuousClean ST system
- Precision-engineered patented tank, bowl, and trapway create strong siphon during flushing
- AquaPiston® canister optimizes the flow out of the tank, harnessing gravity and the natural powerful reducing cascade of water to increase the power and effectiveness of the flush
- Easy-to-flush canister design requires less force to actuate than a 3" (76 mm) flapper, and has 90% less exposed seal material which resists conditions that cause wear, tear, shrinkage and swelling
- Coordinates with other products in the Kelston collection

Installation

- Three-bolt quick-connect installation
- Standard 12" (305 mm) rough-in
- Seat and supply line sold separately

Included Components

K-43200 Tall elongated toilet bowl



Codes/Standards

ASME A112.19.2/CSA B45.1
DOE - Energy Policy Act 1992
EPA WaterSense®
California Energy Commission (CEC)

KOHLER® Toilets and Seats Limited Warranty

See website for detailed warranty information.

1-800-4KOHLER (1-800-456-4537)

Kohler Co. reserves the right to make revisions without notice to product specifications.

For the most current Specification Sheet, go to www.kohler.com USA or www.kohler.ca Canada

8-27-2024 22:40 - US/CA

THE BOLD LOOK
OF **KOHLER®**

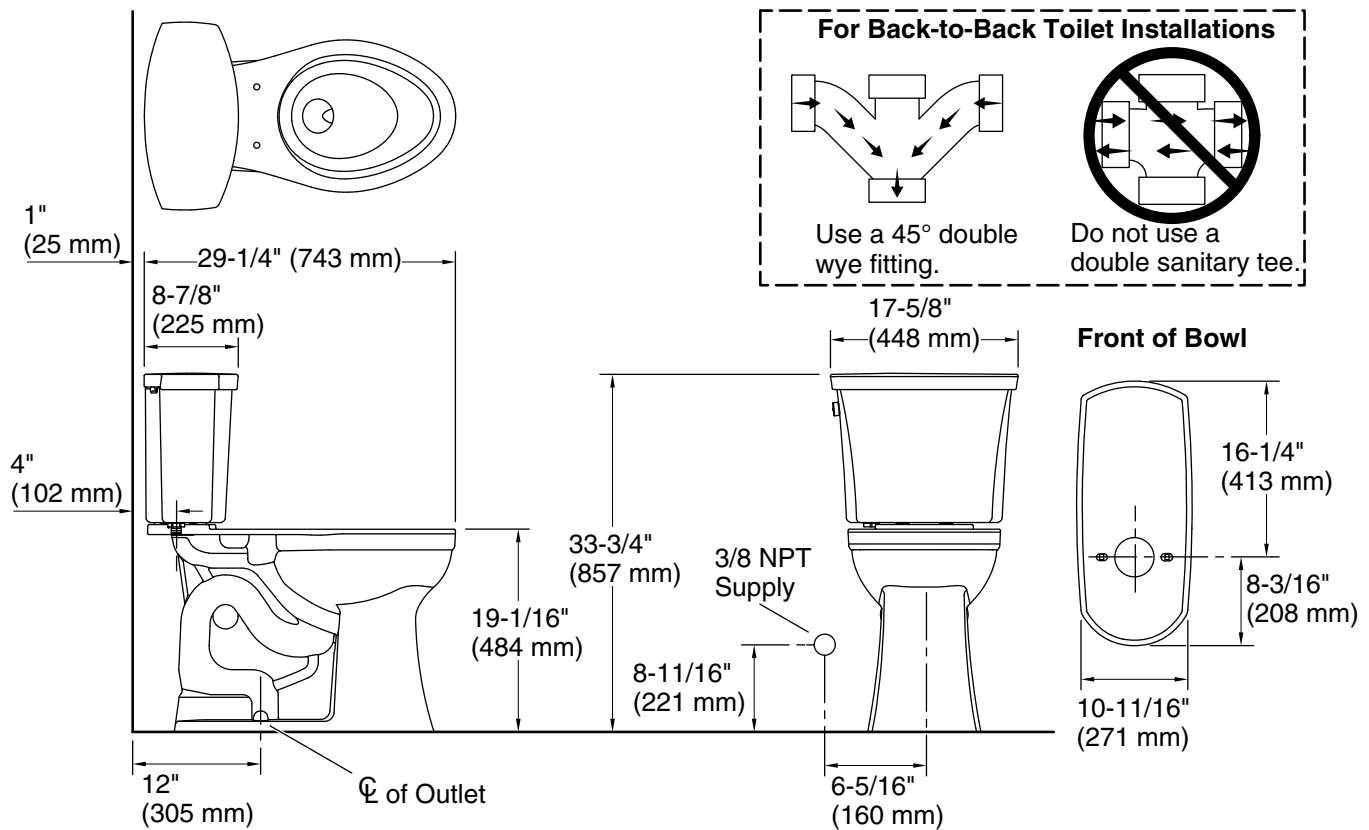

Technical Information

All product dimensions are nominal.

Toilet type:	Floor-mount
Waste Outlet:	Floor
Flush type:	AquaPiston
Trap passageway:	2-1/8" (54 mm)
Water surface size:	10" x 8" (254 mm x 203 mm)
Rim to water surface:	6-3/4" (171 mm)
Rough-in:	12" (305 mm)
Seat-mounting holes:	5-1/2" (140 mm)

Notes

Install this product according to the installation instructions.